

DEWALT®

XR LI-ION

www.DEWALT.com

DCN890

Fig. A

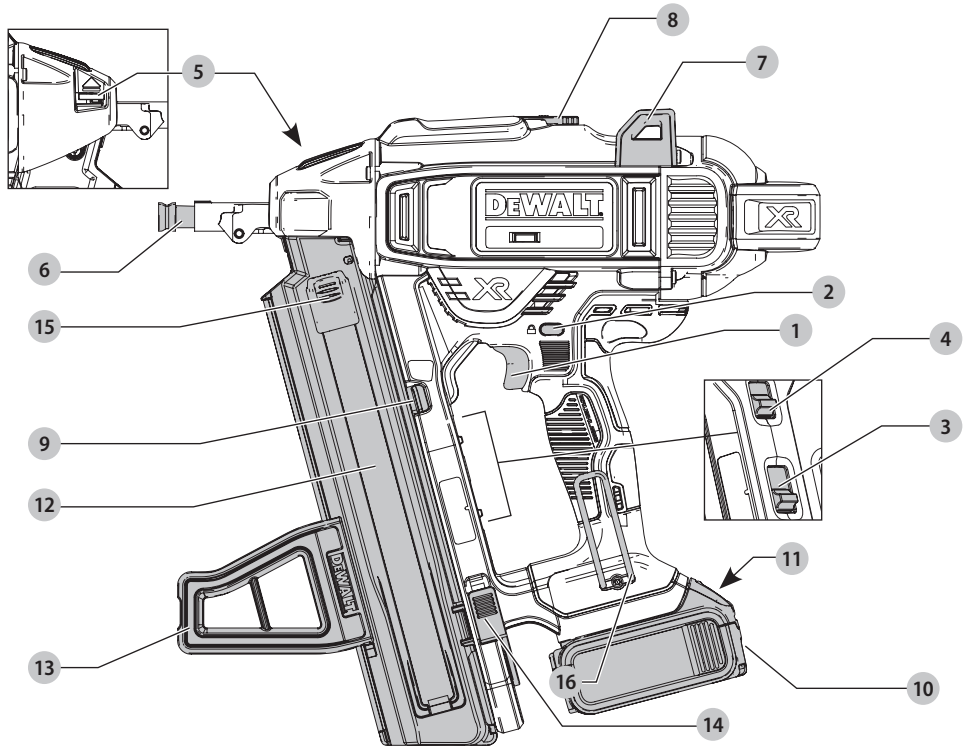

Fig. B

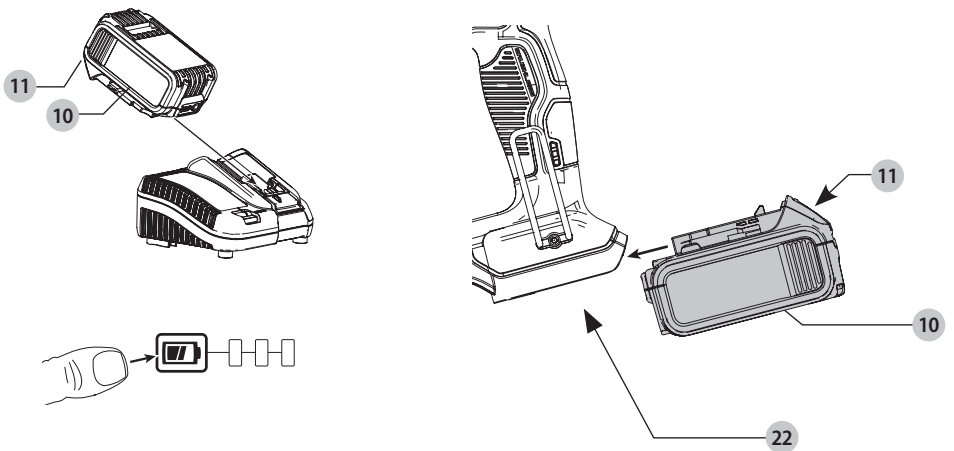

Fig. C

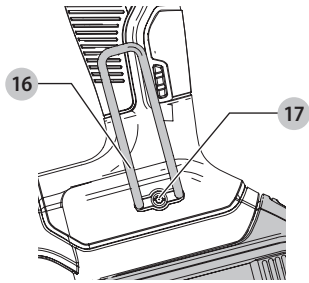

Fig. D

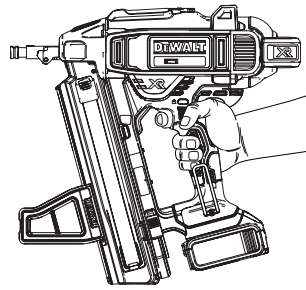

Fig. E

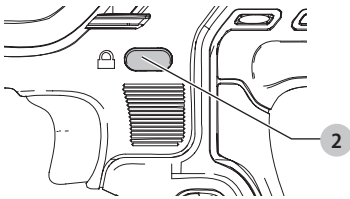

Fig. F

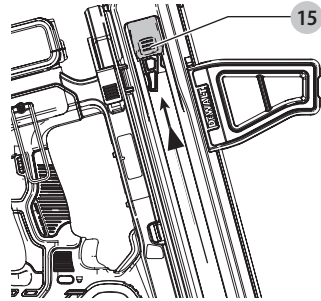

Fig. G

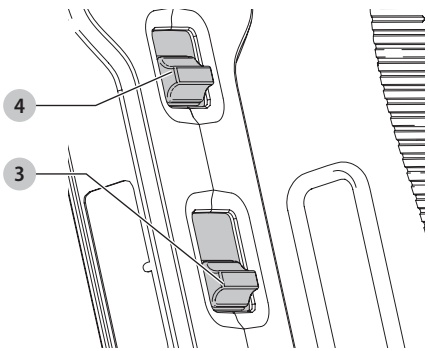

Fig. H

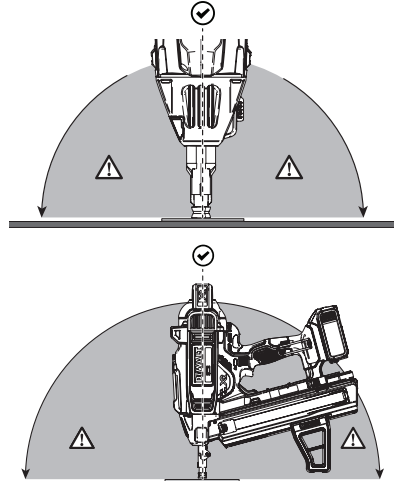

Fig. I

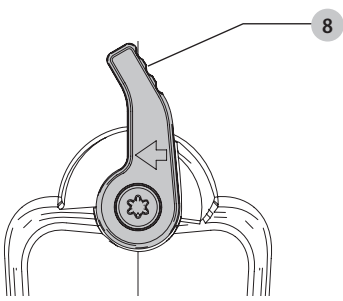

Fig. J

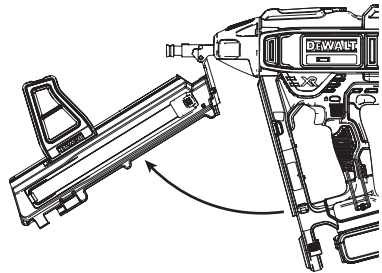

Fig. K

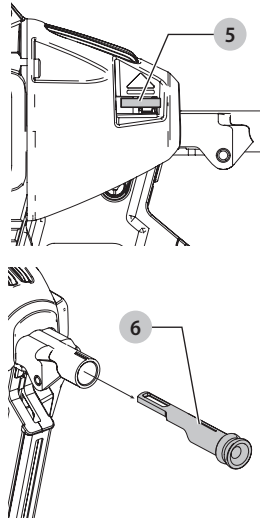

Fig. L

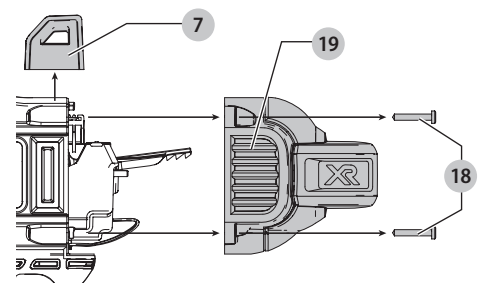

Fig. M

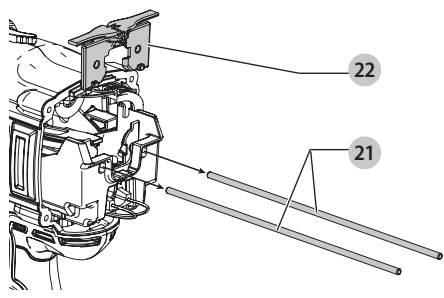
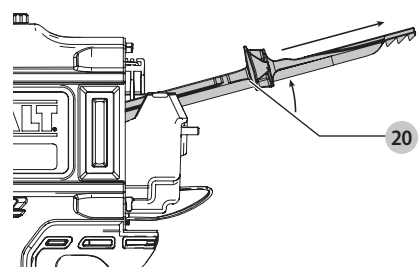

Fig. N



CORDLESS CONCRETE NAILER

DCN890

Congratulations!

You have chosen a DEWALT tool. Years of experience, thorough product development and innovation make DEWALT one of the most reliable partners for professional power tool users.

Technical Data

| | | DCN890 |
|-------------------------------|----------|---------------|
| Voltage | V_{DC} | 18 |
| Type | | 1 |
| Battery type | | Li-Ion |
| Magazine angle | | 15 |
| Loading capacity | | up to 33 pins |
| Length of Pins | mm | 13–57 |
| Pin Thickness | mm | 2.6–3.7 |
| Weight (without battery pack) | kg | 4.2 |

Noise values and vibration values (triax vector sum) according to EN60745-2-16

| | | |
|---|---------|------|
| L_{PA} (emission sound pressure level) | dB(A) | 88.5 |
| L_{WA} (sound power level) | dB(A) | 97.5 |
| K (uncertainty for the given sound level) | dB(A) | 3.5 |
| | | |
| Vibration emission value a_{hv} = | m/s^2 | 2.8 |
| Uncertainty K = | m/s^2 | 1.5 |

The vibration emission level given in this information sheet has been measured in accordance with a standardised test given in EN60745 and may be used to compare one tool with another. It may be used for a preliminary assessment of exposure.



WARNING: The declared vibration emission level represents the main applications of the tool. However if the tool is used for different applications, with different accessories or poorly maintained, the vibration emission may differ. This may significantly increase the exposure level over the total working period.

An estimation of the level of exposure to vibration should also take into account the times when the tool is switched off or when it is running but not actually doing the job. This may significantly reduce the exposure level over the total working period.

Identify additional safety measures to protect the operator from the effects of vibration such as: maintain the tool and the accessories, keep the hands warm, organisation of work patterns.

EC-Declaration of Conformity

Machinery Directive



Cordless Concrete Nailer

DCN890

DEWALT declares that these products described under **Technical Data** are in compliance with:

2006/42/EC, EN60745-1:2009+A11:2010, EN60745-2-16:2010.

These products also comply with Directive 2014/30/EU and 2011/65/EU. For more information, please contact DEWALT at the following address or refer to the back of the manual.

The undersigned is responsible for compilation of the technical file and makes this declaration on behalf of DEWALT.

Markus Rompel
Director Engineering
DEWALT, Richard-Klinger-Straße 11,
D-65510, Idstein, Germany
26.01.2017



WARNING: To reduce the risk of injury, read the instruction manual.

Definitions: Safety Guidelines

The definitions below describe the level of severity for each signal word. Please read the manual and pay attention to these symbols.



DANGER: Indicates an imminently hazardous situation which, if not avoided, **will** result in **death or serious injury**.



WARNING: Indicates a potentially hazardous situation which, if not avoided, **could** result in **death or serious injury**.



CAUTION: Indicates a potentially hazardous situation which, if not avoided, **may** result in **minor or moderate injury**.

NOTICE: Indicates a practice **not related to personal injury** which, if not avoided, **may** result in **property damage**.



Denotes risk of electric shock.



Denotes risk of fire.

General Power Tool Safety Warnings



WARNING: Read all safety warnings and all instructions. Failure to follow the warnings and

| Batteries | | | | Chargers/Charge Times (Minutes) | | | | | |
|-----------|-----------------|---------|-----------|---------------------------------|--------|--------|--------|--------|--------|
| Cat # | V _{DC} | Ah | Weight kg | DCB107 | DCB113 | DCB115 | DCB118 | DCB132 | DCB119 |
| DCB546 | 18/54 | 6.0/2.0 | 1.05 | 270 | 140 | 90 | 60 | 90 | X |
| DCB547 | 18/54 | 9.0/3.0 | 1.25 | 420 | 220 | 140 | 85 | 140 | X |
| DCB181 | 18 | 1.5 | 0.35 | 70 | 35 | 22 | 22 | 22 | 45 |
| DCB182 | 18 | 4.0 | 0.61 | 185 | 100 | 60 | 60 | 60 | 120 |
| DCB183/B | 18 | 2.0 | 0.40 | 90 | 50 | 30 | 30 | 30 | 60 |
| DCB184/B | 18 | 5.0 | 0.62 | 240 | 120 | 75 | 75 | 75 | 150 |
| DCB185 | 18 | 1.3 | 0.35 | 60 | 30 | 22 | 22 | 22 | X |
| DCB187 | 18 | 3.0 | 0.48 | 140 | 70 | 45 | 45 | 45 | 90 |

instructions may result in electric shock, fire and/or serious injury.

SAVE ALL WARNINGS AND INSTRUCTIONS FOR FUTURE REFERENCE

The term "power tool" in the warnings refers to your mains-operated (corded) power tool or battery-operated (cordless) power tool.

1) Work area safety

- Keep work area clean and well lit.** Cluttered or dark areas invite accidents.
- Do not operate power tools in explosive atmospheres, such as in the presence of flammable liquids, gases or dust.** Power tools create sparks which may ignite the dust or fumes.
- Keep children and bystanders away while operating a power tool.** Distractions can cause you to lose control.

2) Electrical safety

- Power tool plugs must match the outlet. Never modify the plug in any way. Do not use any adapter plugs with earthed (grounded) power tools.** Unmodified plugs and matching outlets will reduce risk of electric shock.
- Avoid body contact with earthed or grounded surfaces such as pipes, radiators, ranges and refrigerators.** There is an increased risk of electric shock if your body is earthed or grounded.
- Do not expose power tools to rain or wet conditions.** Water entering a power tool will increase the risk of electric shock.
- Do not abuse the cord. Never use the cord for carrying, pulling or unplugging the power tool. Keep cord away from heat, oil, sharp edges or moving parts.** Damaged or entangled cords increase the risk of electric shock.
- When operating a power tool outdoors, use an extension cord suitable for outdoor use.** Use of a cord suitable for outdoor use reduces the risk of electric shock.

- If operating a power tool in a damp location is unavoidable, use a residual current device (RCD) protected supply.** Use of an RCD reduces the risk of electric shock.

3) Personal safety

- Stay alert, watch what you are doing and use common sense when operating a power tool. Do not use a power tool while you are tired or under the influence of drugs, alcohol or medication.** A moment of inattention while operating power tools may result in serious personal injury.
- Use personal protective equipment. Always wear eye protection.** Protective equipment such as dust mask, non-skid safety shoes, hard hat, or hearing protection used for appropriate conditions will reduce personal injuries.
- Prevent unintentional starting. Ensure the switch is in the off position before connecting to power source and/or battery pack, picking up or carrying the tool.** Carrying power tools with your finger on the switch or energising power tools that have the switch on invites accidents.
- Remove any adjusting key or wrench before turning the power tool on.** A wrench or a key left attached to a rotating part of the power tool may result in personal injury.
- Do not overreach. Keep proper footing and balance at all times.** This enables better control of the power tool in unexpected situations.
- Dress properly. Do not wear loose clothing or jewellery. Keep your hair, clothing and gloves away from moving parts.** Loose clothes, jewellery or long hair can be caught in moving parts.
- If devices are provided for the connection of dust extraction and collection facilities, ensure these are connected and properly used.** Use of dust collection can reduce dust-related hazards.

4) Power tool use and care

- Do not force the power tool. Use the correct power tool for your application.** The correct power tool will do the job better and safer at the rate for which it was designed.

- b) **Do not use the power tool if the switch does not turn it on and off.** Any power tool that cannot be controlled with the switch is dangerous and must be repaired.
- c) **Disconnect the plug from the power source and/or the battery pack from the power tool before making any adjustments, changing accessories, or storing power tools.** Such preventive safety measures reduce the risk of starting the power tool accidentally.
- d) **Store idle power tools out of the reach of children and do not allow persons unfamiliar with the power tool or these instructions to operate the power tool.** Power tools are dangerous in the hands of untrained users.
- e) **Maintain power tools. Check for misalignment or binding of moving parts, breakage of parts and any other condition that may affect the power tool's operation. If damaged, have the power tool repaired before use.** Many accidents are caused by poorly maintained power tools.
- f) **Keep cutting tools sharp and clean.** Properly maintained cutting tools with sharp cutting edges are less likely to bind and are easier to control.
- g) **Use the power tool, accessories and tool bits etc., in accordance with these instructions taking into account the working conditions and the work to be performed.** Use of the power tool for operations different from those intended could result in a hazardous situation.

5) Battery tool use and care

- a) **Recharge only with the charger specified by the manufacturer.** A charger that is suitable for one type of battery pack may create a risk of fire when used with another battery pack.
- b) **Use power tools only with specifically designated battery packs.** Use of any other battery packs may create a risk of injury and fire.
- c) **When battery pack is not in use, keep it away from other metal objects like paper clips, coins, keys, nails, screws or other small metal objects that can make a connection from one terminal to another.** Shorting the battery terminals together may cause burns or a fire.
- d) **Under abusive conditions, liquid may be ejected from the battery; avoid contact. If contact accidentally occurs, flush with water. If liquid contacts eyes, additionally seek medical help.** Liquid ejected from the battery may cause irritation or burns.

6) Service

- a) **Have your power tool serviced by a qualified repair person using only identical replacement parts.** This will ensure that the safety of the power tool is maintained.

Nailer Safety Warnings

- **Always assume that the tool contains fasteners.** Careless handling of the nailer can result in unexpected firing of fasteners and personal injury.
- **Do not point the tool towards yourself or anyone nearby.** Unexpected triggering could discharge a fastener causing an injury.
- **Do not actuate the tool unless the tool is placed firmly against the workpiece.** If the tool is not in contact with the workpiece, the fastener may be deflected away from your target.
- **Disconnect the tool from the power source when the fastener jams in the tool.** While removing a jammed fastener, the nailer may be accidentally activated if it is plugged in.

Additional Nailer Safety Warnings



WARNING: When using any nailer, all safety precautions, as outlined below, should be followed to avoid the risk of death or serious injury. Read and understand all instructions before operating the tool.

- **Hold tool by insulated gripping surfaces when performing an operation where the pin may contact hidden wiring.** Contact with a "live" wire will make exposed metal parts of the tool "live" and shock the operator.
- **Always wear appropriate personal hearing and other protection during use.** Under some conditions and duration of use, noise from this product may contribute to hearing loss.
- **Disconnect battery pack from the tool when not in use.** Always remove battery pack and remove fasteners from magazine before leaving the area or passing the tool to another operator. Do not carry tool to another work area in which changing location involves the use of ladders, stairs, ladders, and the like, with battery pack connected. Do not make adjustments, perform maintenance or clear jammed fasteners while battery is in place.
- **Always use trigger lock-off when tool is not in immediate use.** Using the trigger lock-off will prevent accidental discharge.
- **Do not remove, tamper with, or otherwise cause the tool, trigger or trigger lock-off, to become inoperable.** Do not tape or tie trigger in the on position. Do not remove spring from contact trip. Make daily inspections for free movement of trigger. Uncontrolled discharge could result.
- **Inspect tool before use. Do not operate a tool if any portion of the tool, trigger, or trigger lock-off is inoperable, disconnected, altered, or not working properly.** Damaged parts or missing parts should be repaired or replaced before use. Refer to Maintenance.
- **Do not alter or modify the tool in any way.**
- **Always assume that the tool contains fasteners.**
- **Do not point the tool at co-workers or yourself at any time.** No horseplay! Work safe! Respect the tool as a working implement.
- **Keep bystanders, children, and visitors away while operating a power tool.** Distractions can cause you to lose control. When tool is not in use, it should be locked in a safe place, out of the reach of children.
- **Do not overreach.** Maintain proper footing and balance at all times. Loss of balance may cause personal injury.

- **Use the tool only for its intended use. Do not discharge fasteners into open air or any material too hard for the pin to penetrate. Do not use the body of the tool or top cap as a hammer. Discharged pin may follow unexpected path and cause injury.**
- **Always keep fingers clear of contact trip to prevent injury from inadvertent release of the pin.**
- **Refer to the Maintenance and Repairs sections for detailed information on the proper maintenance of the tool.**
- **Always operate the tool in a clean, lighted area.** Be sure the work surface is clear of any debris and be careful not to lose footing when working in elevated environments such as rooftops.
- **Fasteners must be driven straight into the material.** Do not tilt the nailer while driving fasteners. Personal injury can result from ricocheted or jammed pins.
- **Keep hands and body parts clear of immediate work area.**



WARNING: To avoid injury keep hands and body away from the front discharge area of the tool.

- **Do not use tool in the presence of flammable dust, gases or fumes.** This tool produces sparks that can ignite gases or dust causing an explosion. Driving a pin into another pin may also cause a spark.
- **Keep face and body parts away from back of the tool cap when working in restricted areas.** Sudden recoil can result in impact to the body, especially when nailing into hard or dense material.
- **Grip tool firmly to maintain control while allowing tool to recoil away from work surface as fastener is driven.**
- **Be aware of material thickness when using nailer.** A protruding pin may cause injury.
- **Do not drive pins blindly into walls, floors or other work areas.** Fasteners driven into live electrical wires, plumbing, or other types of obstructions can result in injury.
- **Stay alert, watch what you are doing and use common sense when operating a power tool. Do not use tool while tired or under the influence of drugs, alcohol, or medication.** A moment of inattention while operating power tools may result in serious personal injury.

Residual Risks

In spite of the application of the relevant safety regulations and the implementation of safety devices, certain residual risks cannot be avoided. These are:

- Impairment of hearing.
- Risk of personal injury due to flying particles.
- Risk of burns due to accessories becoming hot during operation.
- Risk of personal injury due to prolonged use.

Electrical Safety

The electric motor has been designed for one voltage only. Always check that the battery pack voltage corresponds to the

voltage on the rating plate. Also make sure that the voltage of your charger corresponds to that of your mains.



Your DEWALT charger is double insulated in accordance with EN60335; therefore no earth wire is required.

If the supply cord is damaged, it must be replaced by a specially prepared cord available through the DEWALT service organisation.

Mains Plug Replacement (U.K. & Ireland Only)

If a new mains plug needs to be fitted:

- Safely dispose of the old plug.
- Connect the brown lead to the live terminal in the plug.
- Connect the blue lead to the neutral terminal.



WARNING: No connection is to be made to the earth terminal.

Follow the fitting instructions supplied with good quality plugs. Recommended fuse: 3 A.

Using an Extension Cable

An extension cord should not be used unless absolutely necessary. Use an approved extension cable suitable for the power input of your charger (see **Technical Data**). The minimum conductor size is 1 mm²; the maximum length is 30 m.

When using a cable reel, always unwind the cable completely.

SAVE THESE INSTRUCTIONS

Chargers

DEWALT chargers require no adjustment and are designed to be as easy as possible to operate.

Important Safety Instructions for All Battery Chargers

SAVE THESE INSTRUCTIONS: This manual contains important safety and operating instructions for compatible battery chargers (refer to **Technical Data**).

- **Before using charger, read all instructions and cautionary markings on charger, battery pack, and product using battery pack.**



WARNING: Shock hazard. Do not allow any liquid to get inside charger. Electric shock may result.



WARNING: We recommend the use of a residual current device with a residual current rating of 30mA or less.



CAUTION: Burn hazard. To reduce the risk of injury, charge only DEWALT rechargeable batteries. Other types of batteries may burst causing personal injury and damage.



CAUTION: Children should be supervised to ensure that they do not play with the appliance.

NOTICE: Under certain conditions, with the charger plugged into the power supply, the exposed charging contacts inside the charger can be shorted by foreign material. Foreign materials of a conductive nature such as, but not limited to, steel wool, aluminum foil or any buildup of metallic particles should be kept away from

charger cavities. Always unplug the charger from the power supply when there is no battery pack in the cavity. Unplug charger before attempting to clean

- **DO NOT attempt to charge the battery pack with any chargers other than the ones in this manual.** The charger and battery pack are specifically designed to work together.
- **These chargers are not intended for any uses other than charging DEWALT rechargeable batteries.** Any other uses may result in risk of fire, electric shock or electrocution.
- **Do not expose charger to rain or snow.**
- **Pull by plug rather than cord when disconnecting charger.** This will reduce risk of damage to electric plug and cord.
- **Make sure that cord is located so that it will not be stepped on, tripped over, or otherwise subjected to damage or stress.**
- **Do not use an extension cord unless it is absolutely necessary.** Use of improper extension cord could result in risk of fire, electric shock, or electrocution.
- **Do not place any object on top of charger or place the charger on a soft surface that might block the ventilation slots and result in excessive internal heat.** Place the charger in a position away from any heat source. The charger is ventilated through slots in the top and the bottom of the housing.
- **Do not operate charger with damaged cord or plug—** have them replaced immediately.
- **Do not operate charger if it has received a sharp blow, been dropped, or otherwise damaged in any way.** Take it to an authorised service centre.
- **Do not disassemble charger; take it to an authorised service centre when service or repair is required.** Incorrect reassembly may result in a risk of electric shock, electrocution or fire.
- **In case of damaged power supply cord the supply cord must be replaced immediately by the manufacturer, its service agent or similar qualified person to prevent any hazard.**
- **Disconnect the charger from the outlet before attempting any cleaning.** This will reduce the risk of electric shock. Removing the battery pack will not reduce this risk.
- **NEVER attempt to connect two chargers together.**
- **The charger is designed to operate on standard 230V household electrical power. Do not attempt to use it on any other voltage.** This does not apply to the vehicular charger.

Charging a Battery (Fig. B)







1. Plug the charger into an appropriate outlet before inserting battery pack.
2. Insert the battery pack **10** into the charger, making sure the battery pack is fully seated in the charger. The red (charging) light will blink repeatedly indicating that the charging process has started.

3. The completion of charge will be indicated by the red light remaining ON continuously. The battery pack is fully charged and may be used at this time or left in the charger. To remove the battery pack from the charger, push the battery release button **11** on the battery pack.

NOTE: To ensure maximum performance and life of lithium-ion battery packs, charge the battery pack fully before first use.

Charger Operation

Refer to the indicators below for the charge status of the battery pack.

| Charge Indicators | | |
|---|----------------------|--|
|  | Charging |  |
|  | Fully Charged |  |
|  | Hot/Cold Pack Delay* |  |

*The red light will continue to blink, but a yellow indicator light will be illuminated during this operation. Once the battery pack has reached an appropriate temperature, the yellow light will turn off and the charger will resume the charging procedure.

The compatible charger(s) will not charge a faulty battery pack. The charger will indicate faulty battery by refusing to light or by displaying problem pack or charger blink pattern.

NOTE: This could also mean a problem with a charger.

If the charger indicates a problem, take the charger and battery pack to be tested at an authorised service centre.

Hot/Cold Pack Delay

When the charger detects a battery pack that is too hot or too cold, it automatically starts a Hot/Cold Pack Delay, suspending charging until the battery pack has reached an appropriate temperature. The charger then automatically switches to the pack charging mode. This feature ensures maximum battery pack life.

A cold battery pack will charge at a slower rate than a warm battery pack. The battery pack will charge at that slower rate throughout the entire charging cycle and will not return to maximum charge rate even if the battery pack warms.

The DCB118 charger is equipped with an internal fan designed to cool the battery pack. The fan will turn on automatically when the battery pack needs to be cooled. Never operate the charger if the fan does not operate properly or if ventilation slots are blocked. Do not permit foreign objects to enter the interior of the charger.

Electronic Protection System

XR Li-Ion tools are designed with an Electronic Protection System that will protect the battery pack against overloading, overheating or deep discharge.

The tool will automatically turn off if the Electronic Protection System engages. If this occurs, place the lithium-ion battery pack on the charger until it is fully charged.

Wall Mounting

These chargers are designed to be wall mountable or to sit upright on a table or work surface. If wall mounting, locate the

charger within reach of an electrical outlet, and away from a corner or other obstructions which may impede air flow. Use the back of the charger as a template for the location of the mounting screws on the wall. Mount the charger securely using drywall screws (purchased separately) at least 25.4 mm long with a screw head diameter of 7–9 mm, screwed into wood to an optimal depth leaving approximately 5.5 mm of the screw exposed. Align the slots on the back of the charger with the exposed screws and fully engage them in the slots.

Charger Cleaning Instructions



WARNING: Shock hazard. Disconnect the charger from the AC outlet before cleaning. Dirt and grease may be removed from the exterior of the charger using a cloth or soft non-metallic brush. Do not use water or any cleaning solutions. Never let any liquid get inside the tool; never immerse any part of the tool into a liquid.

Battery Packs

Important Safety Instructions for All Battery Packs

When ordering replacement battery packs, be sure to include catalogue number and voltage.

The battery pack is not fully charged out of the carton. Before using the battery pack and charger, read the safety instructions below. Then follow charging procedures outlined.

READ ALL INSTRUCTIONS

- **Do not charge or use battery in explosive atmospheres, such as in the presence of flammable liquids, gases or dust.** Inserting or removing the battery from the charger may ignite the dust or fumes.
- **Never force battery pack into charger. Do not modify battery pack in any way to fit into a non-compatible charger as battery pack may rupture causing serious personal injury.**
- **Charge the battery packs only in DeWALT chargers.**
- **DO NOT splash or immerse in water or other liquids.**
- **Do not store or use the tool and battery pack in locations where the temperature may reach or exceed 40 °C (104 °F) (such as outside sheds or metal buildings in summer).**
- **Do not incinerate the battery pack even if it is severely damaged or is completely worn out.** The battery pack can explode in a fire. Toxic fumes and materials are created when lithium-ion battery packs are burned.
- **If battery contents come into contact with the skin, immediately wash area with mild soap and water.** If battery liquid gets into the eye, rinse water over the open eye for 15 minutes or until irritation ceases. If medical attention is needed, the battery electrolyte is composed of a mixture of liquid organic carbonates and lithium salts.
- **Contents of opened battery cells may cause respiratory irritation.** Provide fresh air. If symptoms persists, seek medical attention.



WARNING: Burn hazard. Battery liquid may be flammable if exposed to spark or flame.



WARNING: Never attempt to open the battery pack for any reason. If battery pack case is cracked or damaged, do not insert into charger. Do not crush, drop or damage battery pack. Do not use a battery pack or charger that has received a sharp blow, been dropped, run over or damaged in any way (i.e., pierced with a nail, hit with a hammer, stepped on). Electric shock or electrocution may result. Damaged battery packs should be returned to service centre for recycling.



WARNING: Fire hazard. Do not store or carry the battery pack so that metal objects can contact exposed battery terminals. For example, do not place the battery pack in aprons, pockets, tool boxes, product kit boxes, drawers, etc., with loose nails, screws, keys, etc.



CAUTION: When not in use, place tool on its side on a stable surface where it will not cause a tripping or falling hazard. Some tools with large battery packs will stand upright on the battery pack but may be easily knocked over.

Transportation



WARNING: Fire hazard. Transporting batteries can possibly cause fire if the battery terminals inadvertently come in contact with conductive materials. When transporting batteries, make sure that the battery terminals are protected and well insulated from materials that could contact them and cause a short circuit.

DeWALT batteries comply with all applicable shipping regulations as prescribed by industry and legal standards which include UN Recommendations on the Transport of Dangerous Goods; International Air Transport Association (IATA) Dangerous Goods Regulations, International Maritime Dangerous Goods (IMDG) Regulations, and the European Agreement Concerning The International Carriage of Dangerous Goods by Road (ADR). Lithium-ion cells and batteries have been tested to section 38.3 of the UN Recommendations on the Transport of Dangerous Goods Manual of Tests and Criteria.

In most instances, shipping a DeWALT battery pack will be excepted from being classified as a fully regulated Class 9 Hazardous Material. In general, only shipments containing a lithium-ion battery with an energy rating greater than 100 Watt Hours (Wh) will require being shipped as fully regulated Class 9. All lithium-ion batteries have the Watt Hour rating marked on the pack. Furthermore, due to regulation complexities, DeWALT does not recommend air shipping lithium-ion battery packs alone regardless of Watt Hour rating. Shipments of tools with batteries (combo kits) can be air shipped as excepted if the Watt Hour rating of the battery pack is no greater than 100 Whr. Regardless of whether a shipment is considered excepted or fully regulated, it is the shipper's responsibility to consult the latest regulations for packaging, labeling/marketing and documentation requirements.

The information provided in this section of the manual is provided in good faith and believed to be accurate at the time the document was created. However, no warranty, expressed or implied, is given. It is the buyer's responsibility to ensure that its activities comply with the applicable regulations.

Transporting the FLEXVOLT™ Battery

The DeWALT FLEXVOLT™ battery has two modes: **Use** and **Transport**.

Use Mode: When the FLEXVOLT™ battery stands alone or is in a DeWALT 18V product, it will operate as an 18V battery. When the FLEXVOLT™ battery is in a 54V or a 108V (two 54V batteries) product, it will operate as a 54V battery.

Transport Mode: When the cap is attached to the FLEXVOLT™ battery, the battery is in Transport mode. Keep the cap for shipping.

When in Transport mode, strings of cells are electrically disconnected within the pack resulting in 3 batteries with a lower Watt hour (Wh) rating as compared to 1 battery with a higher Watt hour rating. This increased quantity of 3 batteries with the lower Watt hour rating can exempt the pack from certain shipping regulations that are imposed upon the higher Watt hour batteries.

For example, the Transport Wh rating might indicate 3 x 36 Wh, meaning 3 batteries of 36 Wh each. The Use Wh rating might indicate 108 Wh (1 battery implied).

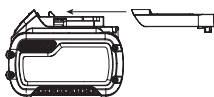

Example of Use and Transport Label Marking



Storage Recommendations

1. The best storage place is one that is cool and dry away from direct sunlight and excess heat or cold. For optimum battery performance and life, store battery packs at room temperature when not in use.
2. For long storage, it is recommended to store a fully charged battery pack in a cool, dry place out of the charger for optimal results.

NOTE: Battery packs should not be stored completely depleted of charge. The battery pack will need to be recharged before use.

Labels on Charger and Battery Pack

In addition to the pictographs used in this manual, the labels on the charger and the battery pack may show the following pictographs:



Read instruction manual before use.



See **Technical Data** for charging time.



Do not probe with conductive objects.



Do not charge damaged battery packs.



Do not expose to water.



Have defective cords replaced immediately.



Charge only between 4 °C and 40 °C.



Only for indoor use.



Discard the battery pack with due care for the environment.

LI-ION



Charge DeWALT battery packs only with designated DeWALT chargers. Charging battery packs other than the designated DeWALT batteries with a DeWALT charger may make them burst or lead to other dangerous situations.



Do not incinerate the battery pack.



USE (without transport cap). Example: Wh rating indicates 108 Wh (1 battery with 108 Wh).



TRANSPORT (with built-in transport cap). Example: Wh rating indicates 3 x 36 Wh (3 batteries of 36 Wh).

Battery Type

The DCN890 operates on a 18 volt battery pack. These battery packs may be used: DCB181, DCB182, DCB183, DCB183B, DCB184, DCB184B, DCB185, DCB187, DCB546, DCB547. Refer to **Technical Data** for more information.

Package Contents

The package contains:

- 1 Concrete nailer
 - 1 Charger (P2 models only)
 - 2 Battery packs (P2 models only)
 - 1 Kitbox (P2 models only)
 - 1 Drywall Contact Trip (DCN8904)
 - 1 Non-Magnetic Contact Trip (DCN8903)
 - 1 Instruction manual
- Check for damage to the tool, parts or accessories which may have occurred during transport.
 - Take the time to thoroughly read and understand this manual prior to operation.

Markings on Tool

The following pictographs are shown on the tool:



Read instruction manual before use.



Wear ear protection.



Wear eye protection.



Visible radiation. Do not stare into light.



Length of nails.



Nail thickness.



Loading capacity.



Suitable nail collation angle.

Date Code Position (Fig. B)

The date code **22**, which also includes the year of manufacture, is printed into the housing.

Example:

2017 XX XX
Year of Manufacture

Description (Fig. A)



WARNING: Never modify the power tool or any part of it. Damage or personal injury could result.

- | | |
|------------------------------------|---|
| 1 Trigger | 9 Low battery & jam/stall indicator lights (x2) |
| 2 Trigger lock-off | 10 Battery pack |
| 3 Speed selection switch | 11 Battery release button |
| 4 Sequential and Rapidcycle switch | 12 Magazine |
| 5 Contact trip release lever | 13 Magazine support leg |
| 6 Contact trip | 14 Magazine release lever |
| 7 Removable top stand | 15 Pusher |
| 8 Stall release lever | 16 Utility hook |

Intended Use

Your concrete nailer is intended **ONLY** for use in driving pins into structural steel OR concrete base materials OR fastening wood to concrete. This tool has two operating modes, a sequential operating mode and a unique rapid sequential operating mode (RapidCycle). Read the section of the manual **Selecting the Mode** before using the tool to make sure you are selecting the proper mode for your application.

DO NOT use under wet conditions or in the presence of flammable liquids or gases.

Your concrete nailer is a professional power tool.

Only DEWALT pins recommended by the pin hardware manufacturer and meeting applicable building code requirements should be used in this tool.

This tool is intended for use by construction professionals.

DO NOT let children come into contact with the tool. Supervision is required when inexperienced operators use this tool.

- **Young children and the infirm.** This appliance is not intended for use by young children or infirm persons without supervision.

- This product is not intended for use by persons (including children) suffering from diminished physical, sensory or mental abilities; lack of experience, knowledge or skills unless they are supervised by a person responsible for their safety. Children should never be left alone with this product.

Dry Fire Lock Out

The concrete nailer is equipped with a dry fire lockout which prevents the tool from actuating when the magazine is nearly empty. When 3 pins remain in the magazine, the tool ceases to operate. Refer to **Loading the Tool** to reload a stick of collated pins.

ASSEMBLY AND ADJUSTMENTS



WARNING: To reduce the risk of serious personal injury, turn tool off and disconnect battery pack before making any adjustments or removing/ installing attachments or accessories. An accidental start-up can cause injury.



WARNING: Use only DEWALT battery packs and chargers.

Inserting and Removing the Battery Pack from the Tool (Fig. B)

NOTE: Make sure your battery pack **10** is fully charged.

To Install the Battery Pack into the Tool Handle

1. Align the battery pack **10** with the rails inside the tool's handle (Fig. B).
2. Slide it into the handle until the battery pack is firmly seated in the tool and ensure that you hear the lock snap into place.

To Remove the Battery Pack from the Tool

1. Press the release button **11** and firmly pull the battery pack out of the tool handle.
2. Insert battery pack into the charger as described in the charger section of this manual.

Fuel Gauge Battery Packs (Fig. B)

Some DEWALT battery packs include a fuel gauge which consists of three green LED lights that indicate the level of charge remaining in the battery pack.

To actuate the fuel gauge, press and hold the fuel gauge button. A combination of the three green LED lights will illuminate designating the level of charge left. When the level of charge in the battery is below the usable limit, the fuel gauge will not illuminate and the battery will need to be recharged.

NOTE: The fuel gauge is only an indication of the charge left on the battery pack. It does not indicate tool functionality and is subject to variation based on product components, temperature and end-user application.

Utility Hook (Fig. C)

The DEWALT cordless nailers include an integrated utility hook **16** and can be attached to either side of the tool to accommodate left- or right-handed users.

If the hook is not desired at all, it can be removed from the tool.

To Remove Utility Hook

1. Remove battery pack from tool.
2. To switch the tool from right- to left-hand usage simply remove the screw **17** from the opposite side of the tool and reassemble on the other side.
3. Replace battery pack.

! **WARNING:** Remove pins from magazine before making any adjustments or servicing this tool. Failure to do so may result in serious injury.

! **WARNING:** Disconnect battery pack from tool before making any adjustments, changing accessories, servicing, or moving the tool. Such preventative safety measures reduce the risk of starting the tool accidentally.

! **CAUTION:** When not in use, place tool on its side on a stable surface where it will not cause a tripping or falling hazard. Some tools with large battery packs will stand upright on the battery pack but may be easily knocked over.

OPERATION

Instructions for Use

! **WARNING:** Always observe the safety instructions and applicable regulations.

! **WARNING:** To reduce the risk of serious personal injury, turn tool off and disconnect battery pack before making any adjustments or removing/installing attachments or accessories. An accidental start-up can cause injury.

! **WARNING:** Read the section titled **Nailer Safety Warnings** at the beginning of this manual. Always wear eye and ear protection when operating this tool. Keep the nailer pointed away from yourself and others. For safe operation, complete the following procedures and checks before each use of the nailer.

1. Wear proper eye, hearing and respiratory protection.
2. Remove battery pack from tool.
3. Lock the pusher **15** in the back position and remove all pins from the magazine.
4. Check for smooth and proper operation of contact trip and pusher latch. Do not use tool if either assembly is not functioning properly. **NEVER** use a tool that has the contact trip restrained in the up position.
5. **NEVER** use a tool that has damaged parts.

! **WARNING:** To reduce the risk of personal injury, disconnect battery pack from tool before performing maintenance, clearing a jammed pin, leaving work area, moving tool to another location or handing the tool to another person.

Proper Hand Position (Fig. D)

! **WARNING:** To reduce the risk of serious personal injury, **ALWAYS** use proper hand position as shown.

! **WARNING:** To reduce the risk of serious personal injury, **ALWAYS** hold securely in anticipation of a sudden reaction.

Proper hand position requires one hand on the main handle as shown in Fig. D.

Preparing the Tool (Fig. A)

NOTICE: **NEVER** spray or in any other way apply lubricants or cleaning solvents inside the tool. This can seriously affect the life and performance of the tool.



NOTE: The battery pack is not fully charged out of the carton. Follow instructions outlined (refer to **Charging Operations**).

1. Read the **Nailer Safety Warnings** section of this manual.
2. Wear eye and ear protection.
3. Remove battery from tool.
4. Ensure magazine is empty of all fasteners.
5. Check for smooth and proper operation of contact trip and pusher latch **15**. Do not use tool if either assembly is not functioning properly. **NEVER** use a tool that has the contact trip restrained in the actuated position.
6. Keep tool pointed away from yourself and others.
7. Insert fully charged battery pack.

Using the Trigger Lock-off (Fig. E)

! **WARNING:** To reduce the risk of serious personal injury, do not keep trigger depressed when tool is not in use. Keep the trigger lock-off switch **LOCKED** (Fig. E) when the tool is not in use.

! **WARNING:** To reduce the risk of serious personal injury, lock off trigger, disconnect battery pack from tool and remove pins from magazine before making adjustments.

Each DEWALT nailer is equipped with a trigger lock-off **2** which when pushed to the right as shown in Figure E, prevents the tool from firing a pin by locking the trigger and bypassing power to the motor.

When the trigger lock-off is pressed to the left, the tool will be fully operational. The trigger lock-off should always be locked off (Fig. E) whenever any adjustments are made or when tool is not in immediate use.

NOTICE: Do not store tool with battery pack installed. To prevent damage to the pack and to ensure best battery life, store battery packs out of the tool or charger in a cool, dry location.

Loading the Tool (Fig. F)

! **WARNING:** Keep the tool pointed away from yourself and others.

! **WARNING:** Never load pins with the contact trip or trigger activated.

 **WARNING:** Always remove battery pack before loading or unloading pins.

 **CAUTION:** Keep fingers clear of pusher latch track to prevent injury.

 **WARNING:** The trigger lock-off should always be engaged whenever any adjustments are made or when tool is not in use.

 **WARNING:** Fasteners used to install metal connectors must meet the requirements of the applicable building codes and must be installed in compliance with code requirements and metal connector hardware supplier specifications. Failure to properly install connectors may result in structural failures.

1. Turn the nailer upside down.
2. Slide the spring-loaded pusher latch **15** to the base of the magazine to lock it into place.
3. Drop pin strips into the loading slot of the magazine, making sure the pin heads align correctly with the slot opening. (Refer to **Technical Data** to determine compatible size.)
4. Keeping fingers clear of the track, close the magazine by releasing the pusher latch. Carefully allow the latch to slide forward and engage the pin strip.

Unloading the Tool

 **WARNING:** The trigger lock-off should always be locked off whenever any adjustments are made or when tool is not in use.

1. Remove the battery from your nailer.
2. Slide the spring-loaded pusher latch to the base of the magazine to lock it into place.
3. Tip the tool up until the fastener strip slides freely out of the magazine.
4. With battery removed, check the nosepiece to verify there are no pins remaining.

NOTE: The tool is equipped with a magnet in the nose area for improved tool performance. When unloading, always verify that the small sticks of pins are not held to the magnetized nose piece.

Speed Setting Summary (Fig. A, G, H)

This nailer is equipped with a speed setting switch **3** to adjust the tool when driving into different materials.

Speed 1: Softer materials (low strength concrete/cinder block)

Speed 2: Medium hardness materials (High strength concrete)

Speed 3: Hard materials (Structural steel)

In the event pins are not driving to depth in speed 1, you may have to switch to speed 2 or 3 for additional driving power.

NOTICE: Driving pins into soft materials at high speed settings will cause excessive wear to your tool and may result in early failures.

| Speed Setting | Application | Typical Pin Length |
|---------------|---|--------------------|
| 1 | Fastening Steel/Wood to Low Strength Concrete/Masonry (<4000 psi) | 19-25 mm |
| 2 | Fastening Steel/Wood to High Strength Concrete (>4000 psi) | 19-29 mm |
| 3 | Fastening to structural steel; 2x4 to Concrete | 13-57 mm |

 **WARNING:** Pins must be driven straight into the material. Do not tilt nailer while driving fasteners. Refer to Fig. H. Pin retention values improve when the tool is fired perpendicular to the material.

The tool can be fired/actuated by pulling the trigger **1** in one of two modes: sequential mode or RapidCycle mode. Refer to **Selecting the Mode** for detailed instructions for firing in each mode.

Selecting the Mode (Fig. A, G)

To select standard sequential mode, slide the mode selector switch **4** to display the single arrow (◀) icon.

To select rapid sequential operating mode (RapidCycle), slide the mode selector switch **4** to display the double arrow (◀◀) icon.

NOTE: Battery life in RapidCycle mode will be shorter than in standard sequential mode. Leaving the tool in standard sequential will give maximum battery life.

Sequential Mode

The sequential mode is used for intermittent nailing. It offers the maximum battery life for driving pins.

1. Using the mode selector switch **4**, select the sequential mode.
2. Release the trigger lock-off **2**.
3. Push the contact trip **6** against the work surface.
4. Pull the trigger switch **1** to actuate the tool.
5. Release the trigger and raise the nailer from the work surface.
6. Repeat steps 3–5 to actuate the next nail.

RapidCycle Mode

In RapidCycle mode, the motor rotation speed is automatically restored after driving a pin to allow fast consecutive nailing. While offering the ability to drive more pins in less time, this mode quickly depletes the battery charge.

1. Using the mode selector switch **4** to select the RapidCycle mode.
2. Release the trigger lock-off **2**.
3. Push the contact trip **6** against the work surface.
4. Pull the trigger switch **1** to actuate the tool.
5. Release the trigger and raise the nailer from the work surface. **NOTE:** The tool motor returns to full speed automatically without the contact trip **6** being depressed.
6. Repeat steps 3–5 to actuate the next nail.

Pin/Fastener Troubleshooting



CONCRETE

Pin does not hold in the concrete.

Cause:

- Too hard/high strength concrete
- Hard or large aggregate in concrete

Action:

- Use shorter pin.
- Switch to higher speed setting.

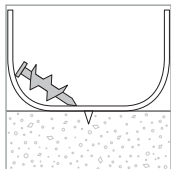

Pin does not drive deep enough.

Cause:

- Pin too long
- Speed setting too low

Action:

- Use shorter pin.
- Switch to higher speed setting.

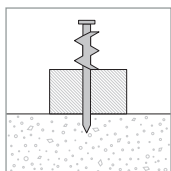

Pin drives too deep.

Cause:

- Pin too short for application
- Speed setting too high

Action:

- Use longer pin.
- Switch to lower speed setting.

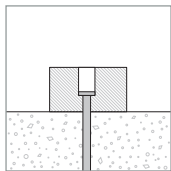

Pin bends.

Cause:

- Pin hit large aggregate on entry
- Too hard/high strength concrete
- Pin hit rebar just under surface

Action:

- Use shorter pin.
- Make sure nailer is perpendicular to the work surface.
- Move 8 cm and try again.

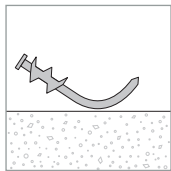

STEEL

Pin does not penetrate the surface.

Cause:

- Speed setting too low
- Material too hard for pin type

Action:

- Increase tool speed setting

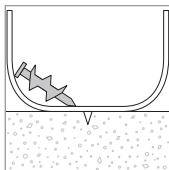

Pin breaks or bends.

Cause:

- Pin too long
- Speed setting too low
- Material too hard for pin type

Action:

- Use shorter pin.
- Switch to higher speed setting.

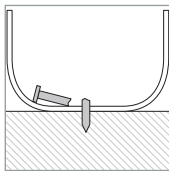

Pin does not hold in the steel.

Cause:

- Steel base material too thin



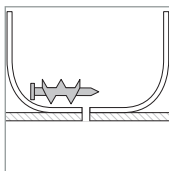

Action:

- Use alternative means to secure base material.



Headlights/LED Indicator (Fig. A)

There are low battery and jam/stall indicator lights  located on the front of the tool on each side of the magazine.

| | |
|--|---|
|  | LOW BATTERY Replace battery with a charged pack. |
|  | HOT PACK Let the battery cool or replace it with a cool pack. |
|  | JAM/STALL CONDITION Rotate the stall release lever to release. Refer to Stall Release or Clearing a Jammed Pin . |
|  | HOT TOOL (Both LEDs Flashing) Let the tool cool down before continuing use. |
|  or any other combination. | ERROR Reset tool by removing and reinserting battery pack or cycling trigger lock off. If error code persist, take tool to an authorised DEWALT service center. |

Stall Release (Fig. I)

If the nailer is used in harder material where all available energy in the motor is used to drive a fastener, the tool may stall.

The driver will not complete the drive cycle and the jam/stall indicator will flash. Rotate the stall release lever **8** on the tool and the mechanism will release. **NOTE:** The tool will disable itself and not reset until the battery pack has been removed and reinserted. If the driver does not automatically return to the home position, proceed to **Clearing a Jammed Pin**. If the unit continues to stall please review the material and fastener length to be sure that it is not too rigorous an application. The nailer could also be overheated and needs time to cool before further use.

Clearing a Jammed Pin (Fig. A, J)



WARNING: To reduce the risk of serious personal injury, disconnect battery pack from tool before making any adjustments, changing accessories, servicing, or moving the tool. Such preventative safety measures reduce the risk of starting the tool accidentally.



CAUTION: When removing a jammed pin, DO NOT orient the nailer with the nose up or with the battery foot up. Positioning the nailer this way makes the jammed pin or pieces of the pin more likely to be ingested into the nailer. If any portion of a pin is ingested into the tool, the pin should be retrieved by removing the top cap.

If a pin becomes jammed in the nosepiece, keep the tool pointed away from you and follow these instructions to clear:

1. Remove battery pack from tool and engage trigger lock-off.
2. After laying the tool on its side, slide the spring-loaded pusher latch **15** to the base of the magazine to lock it into place and unload pin strip.
3. Rotate the magazine release lever **14** and rotate the magazine **12** forward.

4. Remove jammed/bent pin, using pliers if necessary. The contact trip can be removed if necessary. Refer to **Contact Trip Replacement**.



CAUTION: If any portion of a pin is ingested into the tool, the pin should be retrieved by removing the top cap.

5. If the driver is in the down position, rotate the stall release lever on the top of the nailer.

NOTE: If the driver will not reset after rotating the stall release lever, manually resetting the blade with a long screw driver may be necessary.

6. Rotate the magazine back into position under the nose of the tool and close the magazine release lever.

7. Reinsert battery pack.

NOTE: The tool will disable itself and not reset until the battery pack has been removed and reinserted.

8. Reinsert pins into magazine (refer to **Loading the Tool**).

9. Release the pusher latch.

10. Disengage the trigger lock-off when ready to continue nailing.

NOTE: Should pins jam frequently or the driver continually fail to reset, have tool serviced by an authorised DEWALT service centre.

Cold Weather Operation

When operating tools at temperatures below freezing:

1. Keep tool as warm as possible prior to use.
2. Actuate the tool 10 or 15 times into scrap lumber before using.

Hot Weather Operation

Tool should operate normally. However, keep tool out of direct sunlight as excessive heat can deteriorate bumpers and other rubber parts resulting in increased maintenance.

MAINTENANCE

Your DEWALT power tool has been designed to operate over a long period of time with a minimum of maintenance. Continuous satisfactory operation depends upon proper tool care and regular cleaning.



WARNING: To reduce the risk of serious personal injury, turn tool off and disconnect battery pack before making any adjustments or removing/installing attachments or accessories. An accidental start-up can cause injury.

The charger and battery pack are not serviceable.

DAILY MAINTENANCE CHART

| | |
|---------------|---|
| ACTION | Clean magazine, pusher, and contact trip mechanism. |
| WHY | Permits smooth operation of magazine, reduces wear, and prevents jams. |
| HOW | Blowing off the tool with compressed air is the most effective way to clean the tool. The use of oils, lubricants periodically or solvents is not recommended as they tend to attract debris and/or damage the plastic parts of the tool. |
| ACTION | Before each use, check to ensure all screws and fasteners are tight and undamaged. |
| WHY | Prevents jams and premature failure of tool parts. |
| HOW | Tighten loose screws using the appropriate hex wrench or screwdriver. |



Lubrication

NOTICE: NEVER spray or in any other way apply lubricants or cleaning solvents inside the tool. This can seriously affect the life and performance of the tool.

DEWALT tools are properly lubricated at the factory and are ready for use. However, it is recommended that, once a year, you take or send the tool to a certified service centre for a thorough cleaning and inspection.





Cleaning



WARNING: Blow dirt and dust out of the main housing with dry air as often as dirt is seen collecting in and around the air vents. Wear approved eye protection and approved dust mask when performing this procedure.



WARNING: Never use solvents or other harsh chemicals for cleaning the non-metallic parts of the tool. These chemicals may weaken the materials used in these parts. Use a cloth dampened only with water and mild soap. Never let any liquid get inside the tool; never immerse any part of the tool into a liquid.

Optional Accessories



WARNING: Since accessories, other than those offered by DEWALT, have not been tested with this product, use of such accessories with this tool could be hazardous. To reduce the risk of injury, only DEWALT recommended accessories should be used with this product.

Consult your dealer for further information on the appropriate accessories.

Contact Trip Replacment (Fig. F)

For some applications, using a different contact trip may be desirable.



WARNING: For your own safety, read the tool instruction manual before using any accessory. Failure to heed these warnings may result in personal injury and serious damage to the tool and the accessory. When servicing this tool, use only identical replacement parts.

To Replace Contact Trip:

1. Push down on the contact trip release lever **5**.
2. Pull the contact trip **6** out of the nose of the tool.
3. Hold down the trip release lever
4. With the contact trip alignment marker facing up, as shown in Figure K, insert the contact trip fully into the tool nose.
5. Release the lever.

DCN8901 Driver Blade Replacement Kit (Fig. L, M, N)



WARNING: For your own safety, read the tool instruction manual before using any accessory. Failure to heed these warnings may result in serious personal injury and damage to the tool and the accessory. When servicing this tool, use only identical replacement parts.

NOTICE: All the mechanical parts of the driver replacement kit are shown for convenience and verification of inclusion.

To Change a Worn Driver Blade:

1. Using a T-20 Torx, loosen the four screws **18** on either side of the unit.
2. Remove the four screws and the removable top stand **7**. Refer to Figure L.
3. Remove housing end cap **19**. Refer to Figure L.

4. Push up on the rear of the driver **20** until you hear a click, then push the driver forward while holding it in this position until it passes the upper bumper assembly **22**.
 5. Remove guide rods **21**. Refer to Figure M.
 6. Remove upper bumper assembly.
 7. Lift the rear of driver until at an angle and pull the driver out. Refer to Figure N.
 8. Replace driver and follow steps in reverse to reassemble
 9. Ensure new driver slides smoothly through the tool before full reassembly.
 10. Return the driver, guide rods, bumpers, housing end cap, and removable top stand back onto the unit. It is important to try the alignment of the driver and the flywheel before screwing the housing end cap back on to the unit. This can be done by connecting a battery and pushing then releasing the nose of the unit against a bench or hard surface. This will start the motor spinning.
- NOTE:** When the driver and the flywheel are correctly aligned, you will hear the motor coast back down from full speed. If the driver and the flywheel are not correctly aligned, the motor may not start up, may slow down much faster than normal along with a loud grinding noise from the unit. If this happens remove and reset the driver making sure the bumpers are seated correctly.



WARNING: Always test the unit by firing 15 mm, 20 mm or 25 mm pins in Speed 1 into scrap material, to ensure that the tool is working properly. If tool does not operate properly, contact a recognised DEWALT service centre immediately.

Protecting the Environment



Separate collection. Products and batteries marked with this symbol must not be disposed of with normal household waste.

Products and batteries contain materials that can be recovered or recycled reducing the demand for raw materials. Please recycle electrical products and batteries according to local provisions. Further information is available at www.2helpU.com.

Rechargeable Battery Pack

This long life battery pack must be recharged when it fails to produce sufficient power on jobs which were easily done before. At the end of its technical life, discard it with due care for our environment:

- Run the battery pack down completely, then remove it from the tool.
- Li-Ion cells are recyclable. Take them to your dealer or a local recycling station. The collected battery packs will be recycled or disposed of properly.

TROUBLESHOOTING GUIDE



WARNING: To reduce the risk of serious personal injury, turn tool off and disconnect battery pack before making any adjustments or removing/installing attachments or accessories. An accidental start-up can cause injury.

| SYMPTOM | CAUSE | FIX |
|--|--|--|
| Motor does not run with contact trip depressed | Trigger lock in locked position | Unlock trigger lock. |
| | Dryfire lock out engaged, blocking contact trip from traveling fully | Load more pins into magazine. |
| | Tool is stalled, locking the motor from rotating | Rotate the stall release lever on the tool and the mechanism will release. If driver does not return, remove battery and manually push driver back to home position. |
| | Tool is hot. (Check LED indicator to verify these conditions.) | Let the tool cool down before continuing use. |
| | Battery is hot. (Check LED indicator to verify these conditions.) | Let the battery cool or replace it with a cool pack. |
| | Bent contact trip | See authorised service centre. |
| | Motor stops running after 5 seconds | Normal operation, release contact trip and redepress. |
| | Terminals are dirty or damaged | See authorised service centre. |
| | Damaged internal electronics | See authorised service centre. |
| Tool does not actuate (motor runs but will not fire) | Damaged Trigger | See authorised service centre. |
| | Dryfire lock out engaged, blocking contact trip from traveling fully | Load pins into magazine. |
| | Low battery charge or damaged battery | Check charge level if pack shows state-of-charge. Charge or replace battery pack if necessary. |
| | Jammed pin/driver blade not returned to home position | Remove battery, clear jammed pin, cycle stall release lever, (push driver up manually if necessary) reinsert battery pack. |
| | Damaged driver | Replace driver with kit. |
| | Jammed internal mechanism | See authorised service centre. |
| Motor starts up but generates a lot of noise | Damaged internal electronics | See authorised service centre. |
| | Jammed pin and driver is stuck in down position | Use stall release lever, clear and jammed pins, and return driver manually if necessary. |
| Driver blade continues to get stuck in down position | Damaged driver | Replace driver with kit. |
| | Jammed pin and driver is stuck in down position | Use stall release lever, clear any jammed pins, and return driver manually if necessary. |
| | Debris in nosepiece | Clean nose area and watch closely for small pieces of broken pins stuck in the track. Refer to Clearing a Jammed Pin . |
| | Damaged or worn driver | Replace driver with kit. |

ENGLISH

| SYMPTOM | CAUSE | FIX |
|---|--|---|
| Tool operates but does not drive fasteners fully | Speed select setting in wrong position. | Set speed to appropriate setting. |
| | Tool not firmly applied to workpiece | Apply adequate force to tool securing it tightly to workpiece. See instruction manual. |
| | Material and fastener length | If the unit continues to stall (forcing the need to rotate the stall release lever) choose the appropriate material and fastener length that is not too rigorous of an application. |
| | Use of incorrect speed | If trying to drive longer pins in soft woods, or driving pins into harder materials using speed 1 - adjust speed setting to position 2. |
| | Damaged or worn driver tip | Replace driver with kit. |
| | Damaged actuation mechanism | See authorised service centre. |
| Tool operates, but no fastener is driven | No pins in magazine | Load pins in magazine. |
| | Wrong size or angle pins | Use only the recommended pins. Refer to Technical Data . |
| | Debris in nosepiece | Clean nose area and watch closely for small pieces of broken pins stuck in the track. |
| | Debris in magazine | Clean magazine |
| | Damaged or worn driver | Replace driver with kit. |
| | Worn magazine | Replace magazine. See authorised service centre. |
| | Damaged pusher spring | Replace spring. See authorised service centre. |
| Jammed nail | Wrong size or angle pins | Use only the recommended pins Refer to Technical Data . |
| | Magazine not secured after previous jam clear/ inspection | Make sure to magazine is latched properly. |
| | Damaged or worn driver | Replace driver. |
| | Material and fastener length | If the unit continues to stall (forcing the need to rotate the stall release lever) choose the appropriate material and fastener length that is not too rigorous an application. |
| | Debris in nosepiece | Clean nose area and watch closely for small pieces of broken pins stuck in the track. |
| | Damaged pusher spring | Replace springs. See authorised service centre. |
| | Dry fire lock out is engaged with only 2–4 pins remaining in magazine and the user is applying excessive force to contact trip, overriding the lockout | Load more pins in magazine to disengage dryfire lockout. |
| | Tool is not yet run-in | New tools can take 100–500 pins for parts to mesh and wear in together. Drive shorter pins during this period if experiencing difficulty fully driving pins. |
| | Use of incorrect speed | If trying to drive longer pins in soft materials, or driving pins into harder materials using speed 1 - adjust speed setting to position 2 or 3. |
| Worn magazine | Replace magazine. See authorised service centre. | |
| Driver blade does not slide backward and forward smoothly through its firing path | Driver blade is bent | Replace driver. |

| | | | |
|---|--|---|---|
| Belgique et Luxembourg België en Luxemburg | DeWALT - Belgium BVBA Egide Walschaertsstraat 16 2800 Mechelen | Tel: NL 32 15 47 37 63 Tel: FR 32 15 47 37 64 Fax: 32 15 47 37 99 | www.dewalt.be enduser.BE@SBDinc.com |
| Danmark | DeWALT (Stanley Black&Decker AS) Roskildevej 22 2620 Albertslund | Tel: 70 20 15 10 Fax: 70 22 49 10 | www.dewalt.dk kundeservice.dk@sbdinc.com |
| Deutschland | DeWALT Richard Klingler Str. 11 65510 Idstein | Tel: 06126-21-0 Fax: 06126-21-2770 | www.dewalt.de info@wge@sbdinc.com |
| Ελλάς | DeWALT (Ελλάς) A.E. ΕΔΠΑ-ΓΡΑΦΕΙΑ : Στραβόμονος 7 & Α. Βουλιαγμένης, Πλωράδα 166 74, Αθήνα SERVICE : Ημέρος, Τόπος 2 (Χάνι Αδών) – 193 00 Ασπρόπυργος | Τηλ: 00302108981616 Φαξ: 00302108983570 | www.dewalt.gr Greece.Service@sbdinc.com |
| España | DeWALT Ibérica, S.C.A. Parc de Negocios "Mas Blau" Edificio Muntadas, c/Bergadà, 1, Of. A6 08820 El Prat de Llobregat (Barcelona) | Tel: 934 797 400 Fax: 934 797 419 | www.dewalt.es respuesta.postventa@sbdinc.com |
| France | DeWALT 5, allée des Hêtres BP 60105, 69579 Limonest Cedex | Tel: 04 72 20 39 20 Fax: 04 72 20 39 00 | www.dewalt.fr scufi@sbdinc.com |
| Schweiz Suisse Svizzera | DeWALT In der Luberzen 42 8902 Urdorf | Tel: 044 - 755 60 70 Fax: 044 - 730 70 67 | www.dewalt.ch service@rofaag.ch |
| Ireland | DeWALT Building 4500, Kinsale Road Cork Airport Business Park Cork, Ireland | Tel: 00353-2781800 Fax: 01278 1811 | www.dewalt.ie Sales.ireland@sbdinc.com |
| Italia | DeWALT via Energypark 6 20871 Vimercate (MB), IT | Tel: 800-014353 39 039-9590200 Fax: 39 039-9590311 | www.dewalt.it |
| Nederlands | DeWALT Netherlands BVPostbus 83, 6120 AB BORN | Tel: 31 164 283 063 Fax: 31 164 283 200 | www.dewalt.nl |
| Norge | DeWALT Postboks 4613 0405 Oslo, Norge | Tel: 45 25 13 00 Fax: 45 25 08 00 | www.dewalt.no kundeservice.no@sbdinc.com |
| Österreich | DeWALT Werkzeug Vertriebsges m.b.H Oberlaaerstrasse 248, A-1230 Wien | Tel: 01 - 66116 - 0 Fax: 01 - 66116 - 614 | www.dewalt.at service.austria@sbdinc.com |
| Portugal | DeWALT Ed. D Dinis, Quina da Fonte Rua dos Malhoes 2 2A 2º Esq. Oeiras e S. Juliao da Barra, paço de Arcos e Caxias 2770 071 Paço de Arcos | Tel: +351 214667500 Fax: +351214667580 | www.dewalt.pt resposta.postventa@sbdinc.com |
| Suomi | DeWALT PL47 00521 Helsinki, Suomi | Puh: 010 400 4333 Faksi: 0800 411 340 | www.dewalt.fi asiakaspalvelu.fi@sbdinc.com |
| Sverige | DeWALT BOX 94 43122 Mölndal Sverige | Tel: 031 68 61 60 Fax: 031 68 60 08 | www.dewalt.se kundservice.se@sbdinc.com |
| Türkiye | Sanayi ve Ticaret Bakanlığı tebliğine kullanım ömrü 7 yıldır. Stanley Black & Decker Turkey Alet Üretim San. Tic. Ltd.Şti. Kozyatağı Mh Değirmen Sk. Nida Kule No: 18 Kat: 6, 34742 Kadıköy, İstanbul, Türkiye | Tel: +90 216 665 2900 Faks: +90 216 665 2901 | www.dewalt.com.tr info-tr@sbdinc.com |
| United Kingdom | DeWALT 210 Bath Road; Slough, Berks SL1 3YD | Tel: 01753-567055 Fax: 01753-572112 | www.dewalt.co.uk emeaservice@sbdinc.com |
| Australia | DeWALT 810 Whitehorse Road Box Hill VIC 3103 Australia | Tel: Aust 1800 338 002 Tel: NZ 0800 339 258 | www.dewalt.com.au www.dewalt.co.nz |
| Middle East Africa | DeWALT P.O. Box - 17164, Jebel Ali Free Zone (South), Dubai, UAE | Tel: 971 4 812 7400 Fax: 971 4 2822765 | www.dewalt.ae Service.MEA@sbdinc.com |